

REVELATION
by UTTERMOST
ASSEMBLY INSTRUCTIONS

Illustration for Portable version

ITEM NO.:R22554

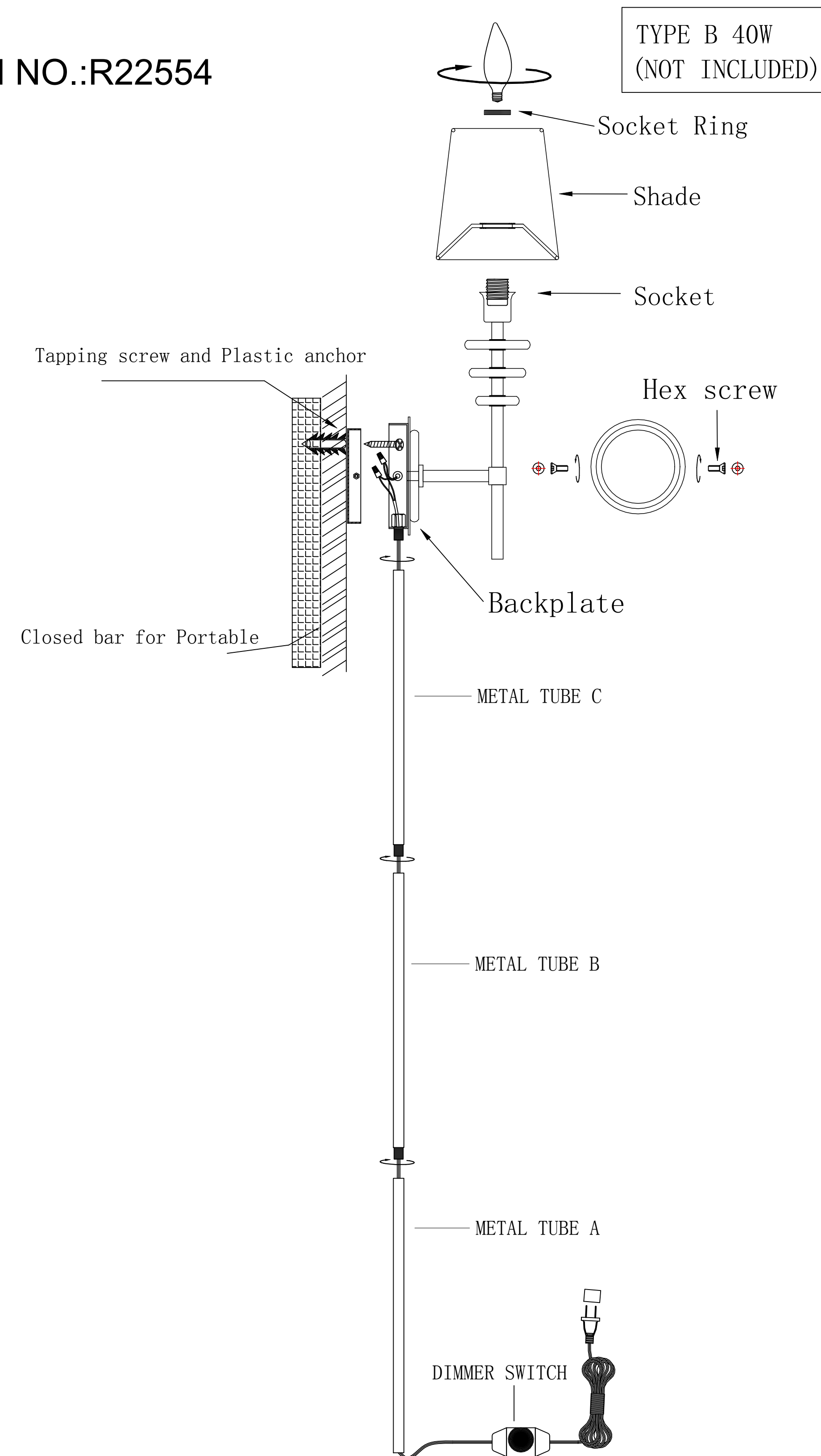

P.O. Box 558 | 3325 Grassy Hill Road | Rocky Mount, VA | 24151
www.uttermost.com/Revelation

REVELATION
by UTTERMOST
ASSEMBLY INSTRUCTIONS

Parts and Hardware List

ITEM NO: R22554

A.	Hex screw	2PCS
B.	Closed Bar for Portable	1PC
C.	Tapping screw	2PCS
D.	Plastic Anchor	2PCS

WARNING: BEFORE INSTALLING, make sure the electricity supply is shut off to avoid a possible electric shock. We suggest a licensed electrician for all installations.

- Carefully remove the parts and hardware from the carton.
- Attach the backplate to fix closed bar, and secure with the hex screw.
- Screw the metal tube C to the lamp body; screw the metal tube B to the metal tube C; screw the metal tube A to the metal tube B.
- The Plastic Anchors and Tapping screws fasten on the wall, then the wall sconce hang on the Tapping screws.
- Place the shade on the socket, and use socket ring to lock until tight.
- Install 40 Watt max, Type B bulb (NOT INCLUDED) into the socket of the fixture.

P.O. Box 558 | 3325 Grassy Hill Road | Rocky Mount, VA | 24151
www.uttermost.com/Revelation

Illustration for Fixture version

ITEM NO.:R22554

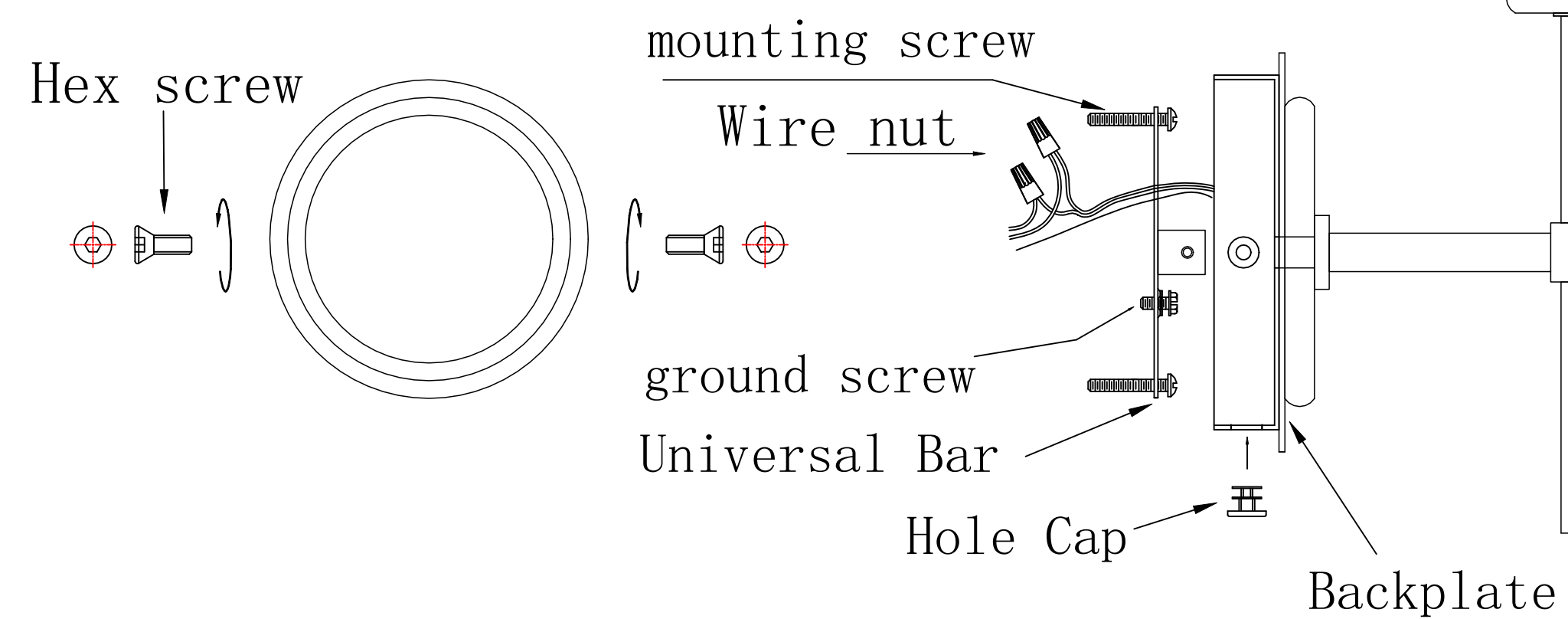
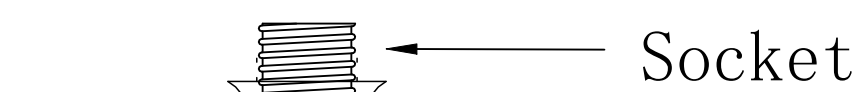
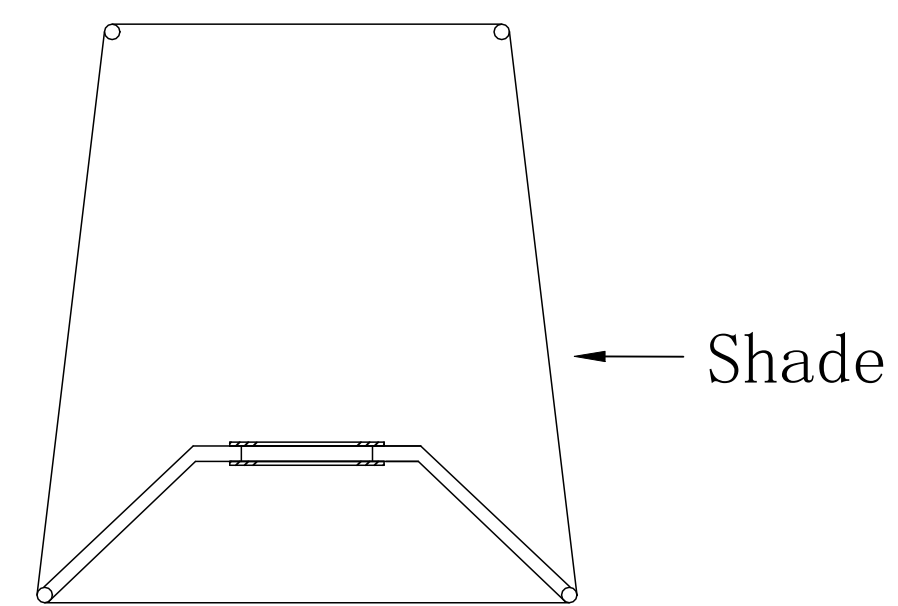
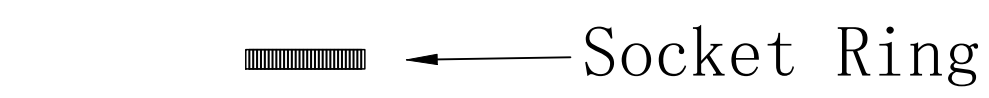
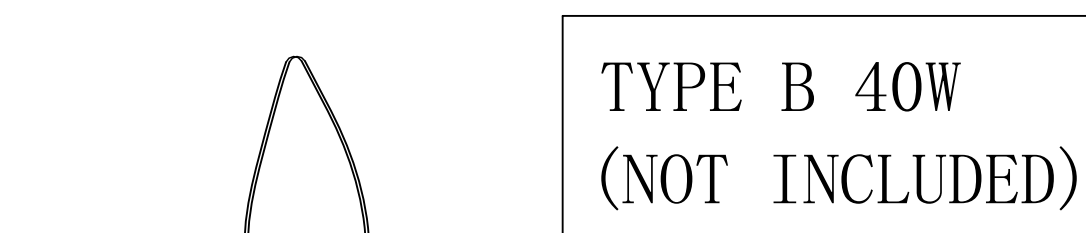
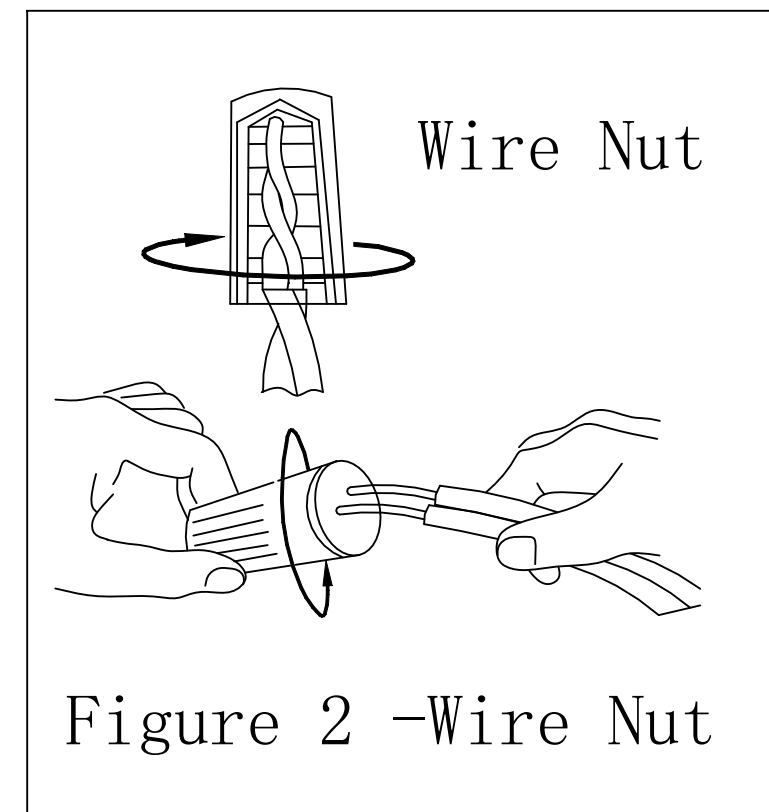

Parts and Hardware List

ITEM NO: R22554

A.	Hole Cap	1PC
B.	Hex Screw	2PCS
C.	Universal Bar	1PC
D.	Mounting Screw	2PCS
E.	Green Ground Screw	1PC
F.	Wire Nut	3PCS
G.	Hole cap	1PC

WARNING: BEFORE INSTALLING, make sure the electricity supply is shut off to avoid a possible electric shock. We suggest a licensed electrician for all installations.

- Carefully remove the parts and hardware from the carton.
- Fasten the Universal bar onto the Outlet Box using the mounting screw .
- Install both ground wires in the Universal bar with the Green Ground Screw supplied.
- Place the white wire, ribbed or tinted wire evenly against the white wire from the outlet box and place the black, smooth or un-tinted wire evenly against the black wire from the outlet box. (Connecting the Wires - See Figure 2)
- Attach the backplate to fix universal bar, and secure with the hex screw.
- Place the shade on the socket, and use socket ring to lock until tight.
- Install 40Watt, Type B bulb (NOT INCLUDED) into the socket of the fixture.